

BAR MIXER BRACKET (compression fit) For Bar Mixers & Bath Shower Mixers

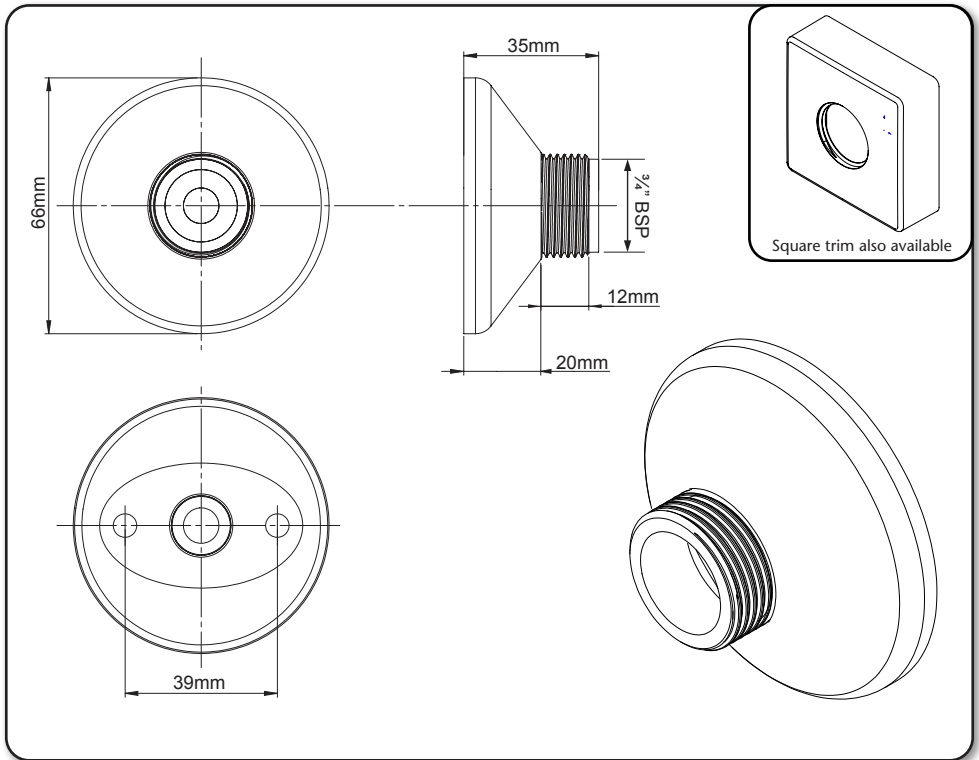

Installation Instructions

INSTALLERS PLEASE NOTE THESE INSTRUCTIONS ARE TO BE LEFT WITH THE USER

2181470E - March 2020

INTRODUCTION

Please read the instructions carefully before beginning installation.

This guide contains all the necessary fitting instructions for your (pipework connector) bar mixer bracket. The bracket has been designed to be surface mounted, using 15mm pipework and can be used with bar mixers or bath shower mixers with $\frac{3}{4}$ " BSP fixings.

The installation must be carried out by a suitably competent person and in the sequence of the instruction book.

The bracket must be mounted onto a surface that is both solid and strong enough to support the final assembly of brackets and bar mixer.

SAFETY WARNINGS

- a. Layout and sizing of pipework must be such that when other services are used, pressures at the mixer control inlets do not fall below the recommended minimum.
- b. **DO NOT choose a position where the mixer shower could become frozen.**
- c. **DO NOT connect to any form of tap or fitting not recommended by the manufacturer.**
- d. Conveniently situated service valves in each inlet supply must be fitted as an independent method of isolating the bracket should maintenance or servicing be necessary.

The bracket is comprised of the components listed in **fig.1**.

Note: Round or square trims will be supplied depending on the product purchased.

Fig.1

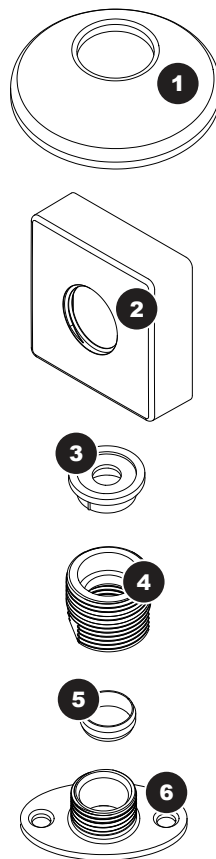

1. Trim pack round x2
2. Trim pack square x2
3. Plastic seal x2
4. Nut x2
5. Olive x2
6. Wall bracket x2

INSTALLATION

IMPORTANT: These bar mixer brackets are designed to be mounted onto a solid structure. If installing to a stud partition wall, dry lined wall or similar, it is recommended that the brackets are secured to the studs or noggins. In this case, the pipework to the brackets should pass through the support studs or noggins via a suitably sized hole (**fig.2**).

Decide upon the mounting position of the brackets on the wall and mark the centres. Check the mounting marks are level and that the distance between them is equal to the distance between the bar mixer inlet centres (**fig.3**).

Mark the route of the pipework to the brackets. The connectors can be used with either 15mm copper or plastic pipework.

Remove the plaster and brickwork (or plasterboard) to the depth required and chase out additional areas of the wall to allow for the incoming pipework. Make sure that enough solid structure of wall remains around the chasing to accommodate the mounting plate wall plugs and screws (**fig.4**).

Complete the pipework to the bracket mounting points.

Leave an excess of pipe protruding out of the wall of approximately 60mm as measured from the face of the finished wall or tiles (**fig.5**).

Flush the pipework through to remove any debris. Check for leaks and remedy as necessary.

Make good the wall and tiles.

Ensure that the pipes exiting the wall are free and can move in and out of the wall by a maximum distance of 4mm (**fig.6**).

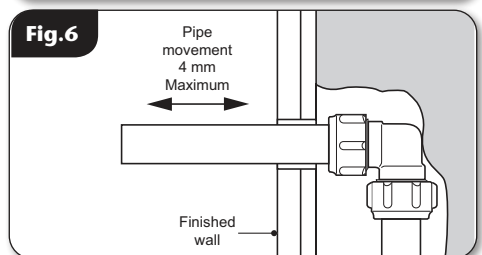
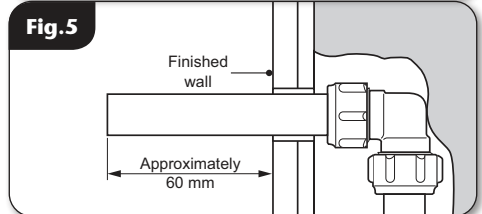
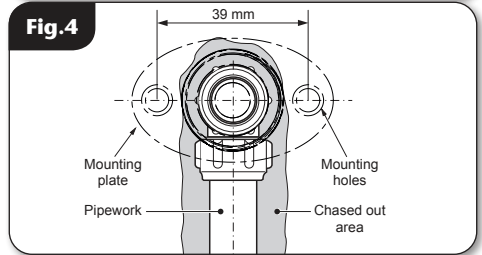
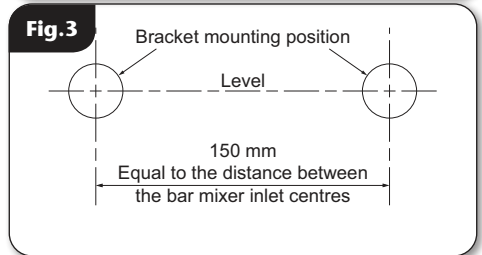
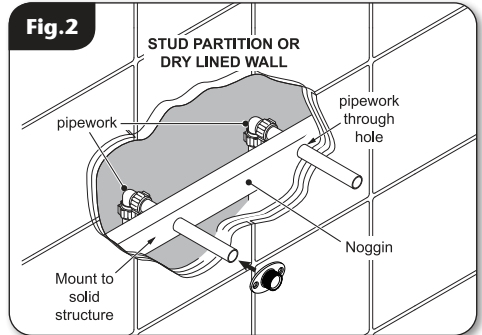

Bar mixer bracket (compression connector)

Push each pipe into the wall until it stops against the depth of chasing. **Measure 21mm to 25mm from the face of the finished wall or tiles and mark the pipe (fig.7).**

The pipes that enter the brackets should be cut using a suitable pipe cutter and deburred.

Make sure the outer surface of the pipes are clean and free of any debris or damage. Clean the surface if necessary.

Mark the positions of the wall bracket holes and drill the wall/tiles to suit.

Slide the wall bracket over the pipework and securely fix to the wall.

Slide the olive over the pipework and push down until it meets the wall bracket. Ensure the olive is clear of the end of the pipework. Ensure pipe does not enter too far into the connector outlet and prevent the plastic seal fitting correctly. Screw the nut onto the wall bracket and tighten until the olive is compressed onto the pipework. **(fig.8)**

Using a suitable sealant, seal the joint between the mounting plate and the wall or tiles to prevent water entering the wall. **(fig.9)**. Wipe away any excess sealant which may obstruct the fitting of the cover trim.

Press the plastic seal into the nut and screw the trim onto the nut until it touches the wall. **(fig.10)**

Fit and secure the bar mixer to the connectors.

Should any replacement parts be required please visit our website or contact our Customer Experience team - details below.

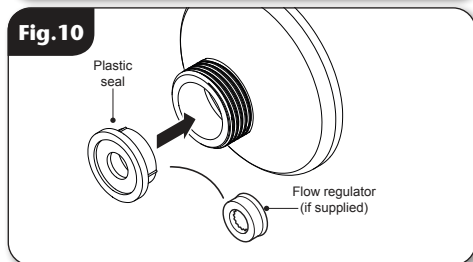
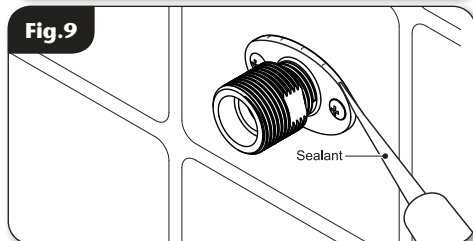
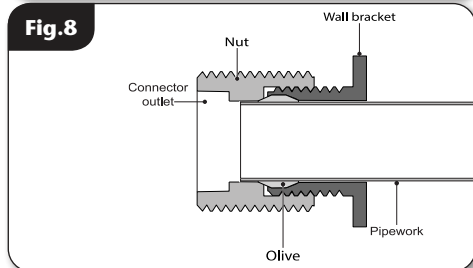
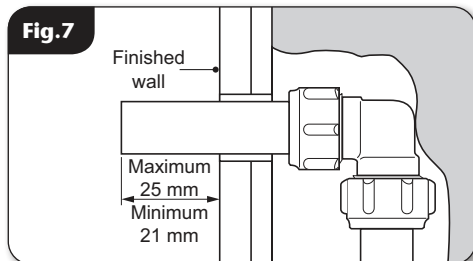

Triton Showers
Triton Road
Nuneaton
Warwickshire CV11 4NR

Triton is a division of Norcross Group (Holdings) Limited

Customer Experience: 024 7637 2222

Trade Installer Hotline: 024 7637 8344

www.tritonshowers.co.uk

E-mail: serviceenquiries@tritonshowers.co.uk

technical@tritonshowers.co.uk

For product guarantee information please go to www.tritonshowers.co.uk/help-and-support

TRITON reserve the right to change product specification without prior notice. E&OE. © TRITON SHOWERS 2020